

CONTRA
ANGLE

UP TO
3 YEARS
WARRANTY



EVO.15

EFFICIENCY FORWARD.

equipped with CoolTouch+™
heat-arresting technology

micro
SERIES

SWISS  MADE

DESIGNED FOR TODAY'S CHALLENGES.

The all-new Contra-Angle EVO.15 is one of a kind, simultaneously raising performance standards and revolutionizing patient safety. This promising electric handpiece combines Swiss precision with an unparalleled level of durability and ergonomics. Discover what makes the Contra-Angle EVO.15 the indispensable dental instrument, day in and day out.



ULTIMATE PRECISION FOR DURABLE PERFORMANCE.

ACCURATE: High efficiency and cutting-edge technology come together on the Contra-Angle EVO.15. The new Accu-Chuck PreciPlus™ bur-retention and rotation drive mechanism* is a perfect example of that – its vibration-canceling properties not only reduce noise interference, they also authorize perfect stability and accuracy no matter the speed and torque. Due to durability being a key contributor to performance, the Contra-Angle EVO.15 is fitted with a specially-designed rotor's head that demonstrates significantly longer service life than conventional models.

The most advanced engineering techniques, skilled company know-how, and up to 3 years¹ of warranty put in your hands the quality and reliability our competitors have been trying to match for over 50 years.

*Available on EVO.15 1:5 L models





WHERE EFFICIENT MEETS EASY.

PRACTICAL: The size of the Contra-Angle EVO.15 makes you forget that you are handling such a high-performance instrument. Its small, shockproof stainless steel head provides remarkable maneuverability and accessibility to third molars. As part of Bien-Air's Micro-Series line, the handpiece's comparatively lighter weight pushes the limits of comfort even further with more balanced manipulation and reduced hand and wrist fatigue.

To maximize user experience, every aspect of the Contra-Angle EVO.15 has been carefully thought-out. The improved Accu-Spray Quattro Mix™ and its dualook™ non-dazzling multi-strand optical glass system support this statement and need to be credited for competent operative field cooling and reliable intraoral visibility.

THE CONFIDENCE YOU HAVE YOUR PATIENTS' TRUST.

SAFE: The Contra-Angle EVO.15 expresses itself in multiple ways, and patient safety is unmistakably at the forefront. Bien-Air's patented* CoolTouch+™** heat-arresting technology brings the handpiece closer to zero risk when it comes to patient burn injuries. Similarly, adverse events linked to bur slippage are prevented, thanks to an extremely efficient fastening system.

When brought together, these combined safety features make the Contra-Angle EVO.15 the safest electric handpiece ever designed.

*Patent pending

**Available on EVO.15 1:5 L models



INNOVATION AND TECHNOLOGY.

Swiss precision every step of the way.



COOLTOUCH+™

Addressing Patient Safety in the Most Responsible Manner

In recent years, the U.S. Food and Drug Administration (FDA) along with other national public health authorities, have reported an alarming increase in patient injuries resulting from electric dental handpieces overheating during procedures.* The most severe cases have caused third-degree burns requiring reconstructive surgery, likely subjecting the practitioner to lengthy legal actions.

While overheating can be an indication of a damaged or clogged instrument, laboratory evaluations reveal that this hazard is just as prevalent in new and properly-maintained electric handpieces.

In a committed effort to promote patient safety, Bien-Air is introducing CoolTouch+™, the world's first and only heat-arresting system proven not to exceed human body temperature.** After years of research and development, this complex proprietary technology is engaged to protect both the patient and the clinician during some of the profession's most frequently performed procedures.

You've worked hard to build a solid reputation. Don't destroy it by compromising patient safety.

Bien-Air's CoolTouch+™ owes its exceptional heat-arresting properties to an ingenious configuration of an alumina bead and a thermally-insulated ceramic push-button. This frontline technology exhibits an invariably safe temperature of the handpiece's head, even in the most rigorous conditions.

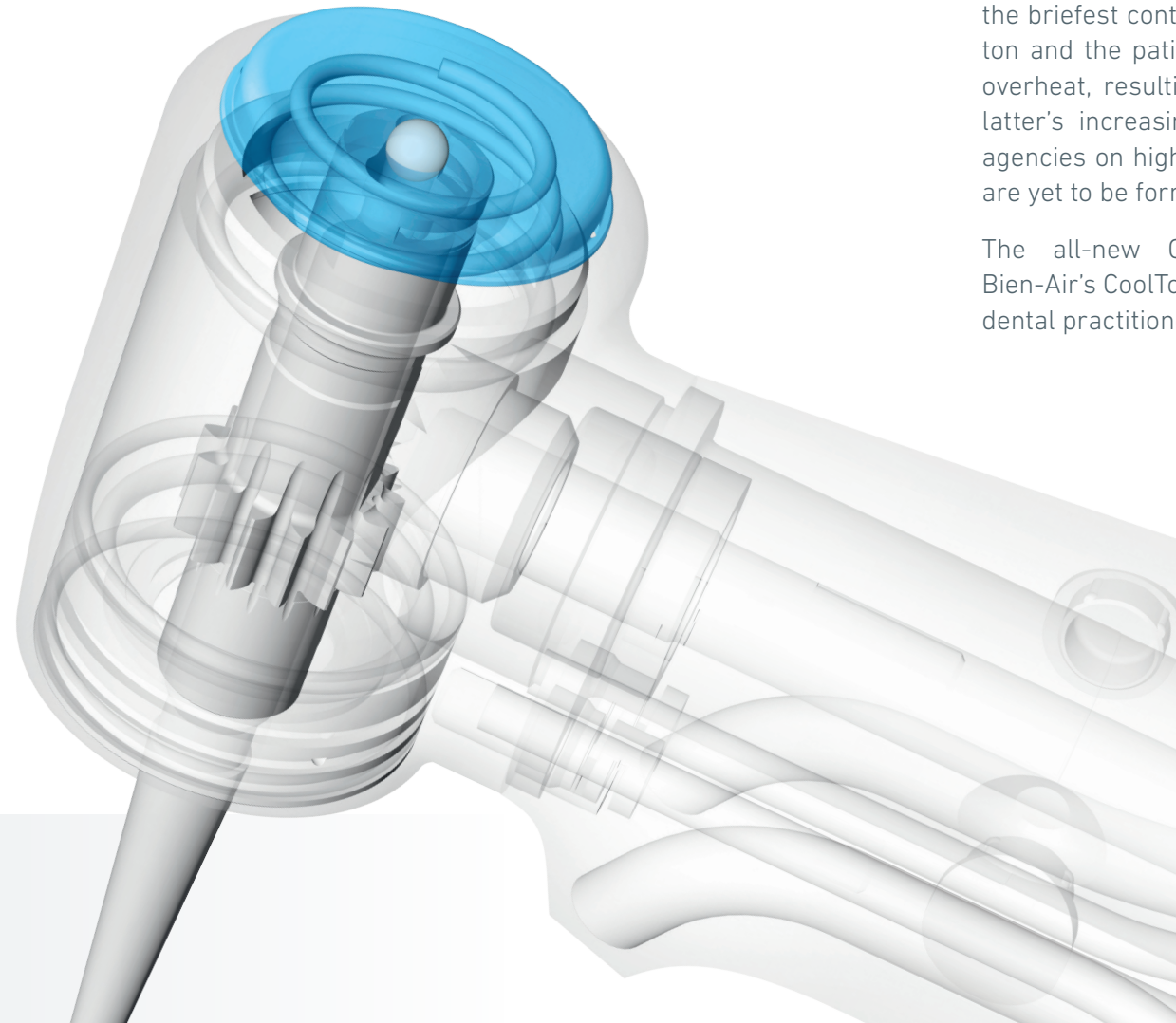

Contra-Angle EVO.15: The Safest Electric Handpiece on the Market

In dental procedures making use of electric handpieces, the briefest contact between the instrument's push-button and the patient's inner-cheek causes the former to overheat, resulting in possible burn injuries. While the latter's increasing frequency is keeping public health agencies on high alert, industry-wide safety regulations are yet to be formulated.

The all-new Contra-Angle EVO.15, equipped with Bien-Air's CoolTouch+™ heat-arresting technology, gives dental practitioners peace of mind in all situations.

For more information
www.CoolTouchPlus.com

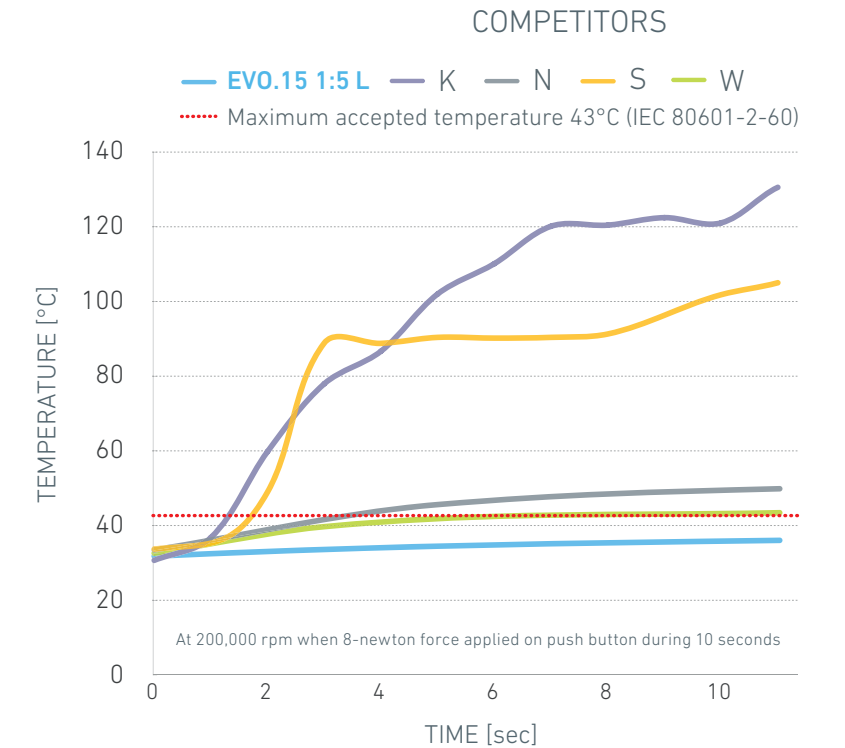

When measured against the most popular electric handpiece manufacturers, Bien-Air's CoolTouch+™ is indisputably the safest anti-heating system available.

* U.S. Food and Drug Administration, «Letter to Electric Dental Handpiece Manufacturers Regarding Reports of Overheating and Patient Burns». (Updated 2014, 06)
** Available on EVO.15 1:5 L models

THE DEFINING FEATURES OF CONTRA-ANGLE EVO.15.*

UP TO 3 YEARS WARRANTY¹

Micro-Series is the combination of Bien-Air's most recent line of compact contra-angles with its new generation micromotors. Up to 30 percent shorter and 23 percent lighter than traditional models, Micro-Series guarantees optimal balance and reduced hand fatigue. Micro-Series, welcome to a new dimension.

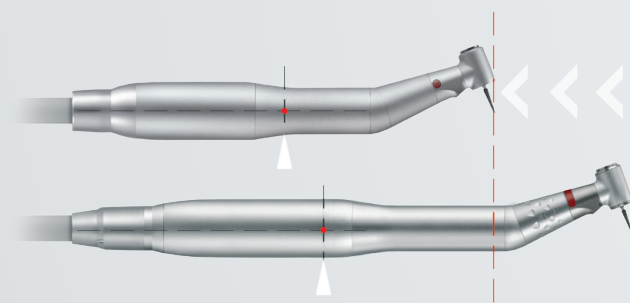

micro
SERIES

* Available on EVO.15 1:5 L models

Accu-Chuck PreciPlus™ bur-locking force vs. Soft Push™ bur-release force

● Bur-release force [N]
■ Bur-locking force [N]
..... Minimum accepted bur-locking force 22 N (ISO 14457)

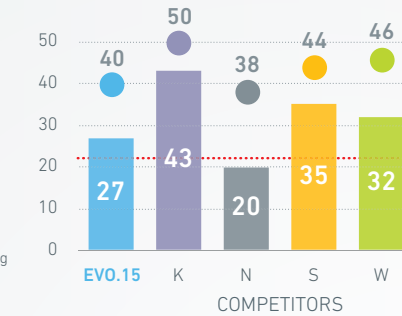

Durability

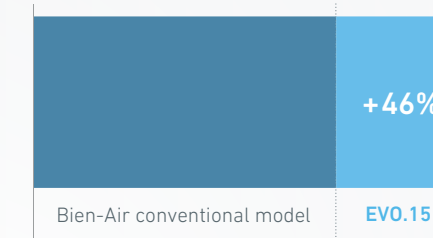

Significant increase compared with Bien-Air conventional model

Accu-Chuck™ PreciPlus bur-locking and rotation drive mechanism

Provides staunch clamping of the bur resulting in vibration-free stability and comfort. Bur changing is quick, accurate, and safe, thanks to Bien-Air's unique Soft Push™ locking system.

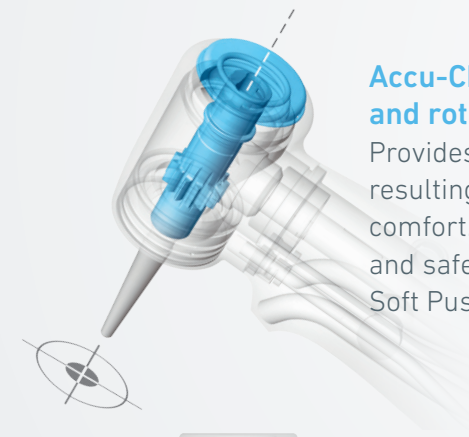

Miniature shockproof head

Facilitates maneuverability, posterior access, and pediatric use.



Accu-Spray Quattro Mix™ with dualook™ illumination

Converges four asymmetrical laser-precise air/water sprays onto the tip of the bur for rapid and even cooling of the operative field. In combination with two multi-strand optical glass conductors, unobscured intraoral visibility is guaranteed.

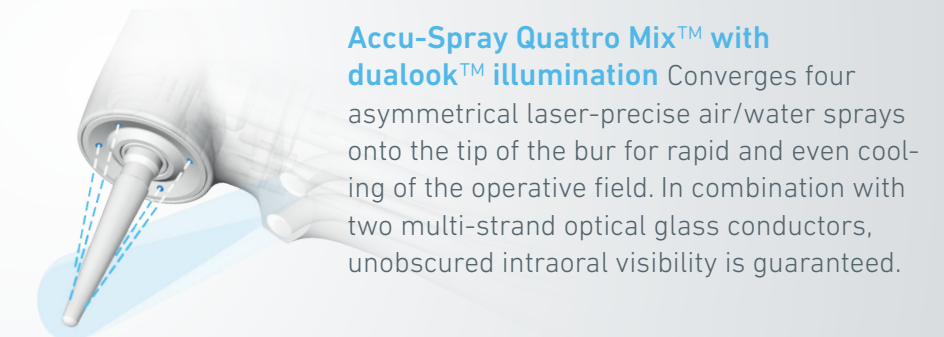

CoolTouch+™ heat-arresting technology

Revolutionizes patient safety by eliminating overheating and associated burn injuries.



BIEN-AIR'S ELECTRIC MICROMOTORS. RELIABLE ENDURANCE.

With close to one million pieces shipped worldwide, Bien-Air's prize-winning electric motors are indisputably the most popular on the market today. They redefine modern dental standards with superior precision and ergonomics.

Bien-Air's last generation micromotors feature brushless technology for superlative performance in both high- and low-speed procedures.

For additional information on Bien-Air's full range of electric micromotors:

dental.bienair.com/micromotors



GREATER POWER AND MORE TORQUE. A major attribute of Bien-Air micromotors is their elevated power output with constant torque for swift and effortless use.

ACCURATE COMMAND. The proprietary Smart Logic™ electronic control lends Bien-Air micromotors a stepless, vibration-free rotation for the most meticulous and precise dental work.

COMPACT AND LIGHTWEIGHT. Bien-Air micromotors are significantly shorter and lighter than conventional models. This results in optimal grip and balance as well as reduced hand fatigue.

MAINTENANCE-FREE. Bien-Air micromotors' ball bearings are greased for life making post-usage lubrication expendable. Built to withstand repeated sterilization cycles, the strictest hygiene standards are upheld.

TECHNICAL DATA.



EVO.15 1:1 L
Std. / Micro-Series



EVO.15 1:5 L
Std. / Micro-Series



CA 1:1 L
Std. / Micro-Series



CA 1.5 L
Std. / Micro-Series

Transmission ratio	● 1:1	● 1:5	● 1:1	● 1:5
Maximum speed (rpm)	40'000	200'000	40'000	200'000
Head	Shockproof head (stainless steel)	Shockproof head (stainless steel)	–	–
Head diameter (mm)	9.4	9.4	9.8	9.8
Head size (mm)	14.1	14.1 mm (21.5 mm with bur 19 mm)	15.3	15.5 mm (22.9 mm with bur 19 mm)
Weight (g)	84 / 76	88 / 80	86 / 78	90 / 82
Noise level (dBA)	55	55	57	58
Spray system	4 asymmetrical mixed air/water sprays	4 asymmetrical mixed air/water sprays	2 x 3 separate air/water sprays	2 x 3 separate air/water sprays
Lighting system	Multi-strand optical glass technology	Multi-strand optical glass technology	Multi-strand optical glass technology	Multi-strand optical glass technology
Anti-heating system	–	Cool Touch+™	–	Cool Touch™
Coupling system	ISO 3694 and Bien-Air Micro-Series	ISO 3694 and Bien-Air Micro-Series	ISO 3694 and Bien-Air Micro-Series	ISO 3694 and Bien-Air Micro-Series
Warranty	2 to 3 years ¹	2 to 3 years ¹	2 to 3 years ¹	2 to 3 years ¹
Reference	EVO.15 1:1 L 1600939-001 EVO.15 1:1 L Micro-Series 1600938-001	EVO.15 1:5 L 1600941-001 EVO.15 1:5 L Micro-Series 1600940-001	CA 1:1 1600424-001 CA 1:1 L 1600384-001 CA 1:1 L Micro-Series 1600691-001	CA 1:5 1600325-001 CA 1:5 L 1600386-001 CA 1:5 L Micro-Series 1600690-001

ENJOY SUPERIOR SERVICE WITH CLUB BIEN-AIR.

By becoming a Club Bien-Air member, you benefit from an acclaimed After Sales service and a full range of advantages.

PRIORITY SERVICE AND REPAIR

Jump in front of the line. Your membership guarantees higher priority for repair and service requests. In selected markets, your products are even picked up from your practice free of charge.

LONGER WARRANTIES

Leave the worrying to us. You can now get an additional 12 months of uninterrupted support through our new Bien-Air PlanCare warranty extension pack.

EXCLUSIVE PROMOTIONS

Ever hear about a great deal after it is too late? Not anymore. As a member, you get access to promotions before they go public.

FREE

The best thing about all this? You never pay to be a Club Bien-Air member.



For additional information or to sign up:
www.club-bienair.com

¹ 2-year standard warranty and 1-year optional warranty available through Bien-Air's PlanCare extended warranty program. Information on www.bienair.com.

For more information
www.bienair-evo15.com

Bien-Air Dental SA

Länggasse 60
Case postale
2500 Bienne 6, Switzerland
Tel. +41 (0)32 344 64 64
Fax +41 (0)32 344 64 91
dental@bienair.com

Bien-Air Deutschland GmbH

Jechtinger Straße 11
79111 Freiburg, Germany
Tel. +49 (0)761 45 57 40
Fax +49 (0)761 47 47 28
ba-d@bienair.com

Bien-Air España SA

Entença, 169 Bajos
08029 Barcelona, Spain
Tel. +34 934 25 30 40
Fax +34 934 23 98 60
ba-e@bienair.com

Bien-Air USA, Inc.

5 Corporate Park
Suite 160
Irvine, CA 92606, USA
Tel: 1-800-433-BIEN
Tel: +1 949-477-6050
Fax +1 949-477-6051
ba-usa@bienair.com

Bien-Air France Sàrl

19-21, rue du 8 Mai 1945
94110 Arcueil, France
Tel. +33 (0)1 49 08 02 60
Fax +33 (0)1 46 64 86 68
ba-f@bienair.com

Bien-Air Italia s.r.l.

Via Vaina 3
20122 Milano, Italy
Tel. +39 02 58 32 12 51
Fax +39 02 58 32 12 53
ba-i@bienair.com

Bien-Air UK Limited

Arundel House,
Unit 1 - Ground Floor
Amberley Court, Whitworth Road
Crawley, RH11 7XL, England
Tel. +44 (0)1293 550 200
Fax +44 (0)1293 520 481
ba-uk@bienair.com

Bien-Air Asia Ltd.

Nishi-Ikebukuro
Daiichi-Seimei Bldg, 10F
2-40-12 Ikebukuro, Toshimaku
Tokyo, 171-0014, Japan
ビエン・エア・アジア株式会社 (製造販売元)
〒171-0014
東京都豊島区池袋2-40-12
西池袋第一生命ビルディング10F
Tel. +81 (3) 5954-7661
Fax +81 (3) 5954-7660
ba-asia@bienair.com

Beijing Bien-Air

Medical Instrument
Technology Service Co. Ltd.
Room 907, The Exchange Beijing,
No 118 Jian Guo Lu Yi,
Chao Yang District,
Beijing 100022, China
北京彼岸医疗器械
技术服务有限公司
北京市朝阳区建国路
乙118号招商局中心
京汇大厦907室
电话: +86 10 6567 0651
传真: +86 10 6567 8047
ba-beijing@bienair.com



www.club-bienair.com



The descriptions and technical data appearing in this document are given as an indication and are not binding. They may not give rise to any claim. Bien-Air reserves the right to make changes without prior notice.
REF 2400345 / 02.2015 / Printed in Switzerland